

Article number: 2301072761

Description: E+G Handwheel
VDS.150+IR-A14

Measures

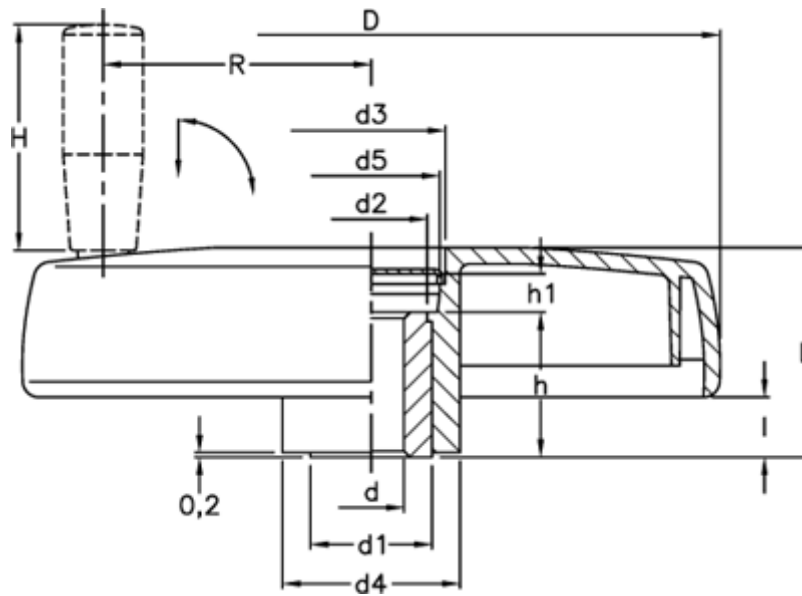

C (N m) = 180	H = 65
D = 150	h = 30
d1 = 26	h1 = 10.0
d2 = 24.0	l = 12.0
d3 = 34.0	L = 44
d4 = 38	L (J) = 15
d5 = 30.0	R = 58
d H7 = 14	